

Varenummer: 2310431063S
Beskrivelse: E+G Stilleben
LX.30-SW17-M8X53-S

Mål

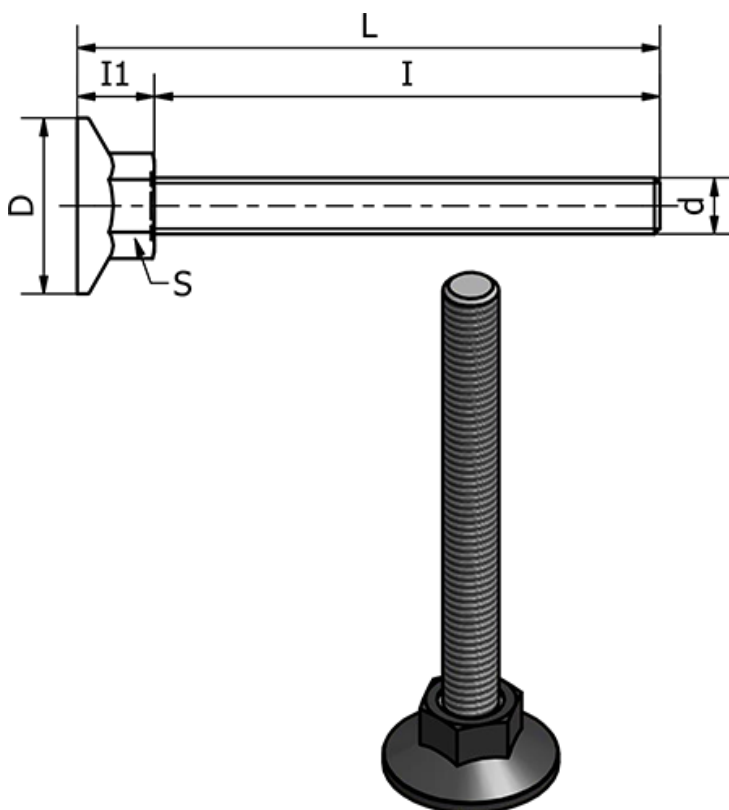

d	= M8
D	= 30
I	= 53
I1	= 12
L	= 65
Max statisk belastning (N)	= 2500
S	= 17
Type	= Forzinket

Vægt (g) = -